

HVAC System

Flagship series

中/大型机房解决方案



List (目录)

Features of flagship series (flagship 产品特点)	1
Specifications for flagship series (flagship 系列规格)	4
Family (家族成员)	5
The standard diameter and electrical data series (标准管径及电气技术数据)	6
Components (零件)	7
Parameters for outdoor units (室外机参数)	8

Features of flagship series (flagship 产品特点):

The flagship series was developed in early 1999 including the new type of energy saving and modular series of temperature and constant humidity air conditioning and micro controller. It retains the advantages of all series, and also increases a lot of new high technology achievements. The products in late 1999 in China and Europe also began selling, by the new and old customers praise.

旗舰型是公司 1999 年初所开发的新型节能及模块式微电脑控制恒温恒湿空调。它不但保留所有系列的优点，同时又增加许多新的高科技技术。产品于 1999 年后期在中国和欧洲同时开始销售，受到新、老客户的赞誉。

Design of flagship series

The flagship series is used the modular design. Single cooling loop and double cooling loop flagship series of precision air conditioning, the refrigeration capacity is from 20KW to 103KW for a single unit which can be combined together. It can satisfy the use at the present stage and can adapt to the needs of future development with a very wide range of applications. It uses an advanced microprocessor control technology that fully meets the requirements for the environment of precision control in the computer room. A controller can complete the timing switching and fault switching for units. It also centralizes the management which is convenient for air conditioning system. Humidification system of flagship series is detachable electrode tank type humidifier.

旗舰型系列机组的设计

旗舰型系列采用真正的模块化设计思路。生产的单制冷回路和双制冷回路旗舰型系列精密空调，可提供单机制冷量的范围为 20KW 至 103KW，并可组合在一起。即能满足现阶段的使用，又能适应未来发展的需求，具有非常广泛的应用范围。它采用了先进的微处理器控制技术，完全满足机房对环境精密控制的要求。并且机组控制器可在各机组间定时切换及故障切换，也便于空调系统集中管理。旗舰型的加湿系统是可拆式电极式加湿器。

In order to adapt many areas of poor water quality, it adopts the control technology which is unique and the use of "fuzzy logic" control software. It can be based on the conductivity of the water current and automatically adjust the value of the electrode. At the same time, it can be determined according to the hardness of water and flushing times for the humidification tank. The humidifier is removable. To clean the humidifier can be continued to use, on the one hand, can prolong the service life of tank. On the other hand, it can make the humidifier that has the highest efficiency. Therefore, it can be used in the electrical conductivity of water that is particularly high environment -- often in remote areas.

为了适应水质很差的地区，它采用独特的控制技术并使用“模糊逻辑”控制软件。它可以根据水的电导率，自动调整电极的电流值。同时，它可以根据水的硬度，确定加湿罐的冲洗次数。加湿器为可拆装式，对加湿器进行清洗后可继续使用，一方面，可以延长加湿罐的使用寿命；另一方面，可以使加湿器达到最高的使用效率。因此，它可以用于水的电导率特别高的环境——常常是在很偏远的地区。

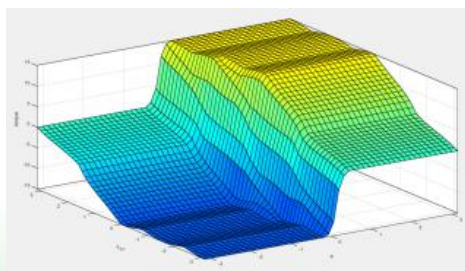

The flagship series uses interactive "type V" coil, the internal thread copper tube and punched slotted fin, and heat transfer efficiency is higher than the traditional coil unit. The "V" structure of coil can make refrigeration system cycle match the refrigeration load, the gas flow through the coil surface is smooth, and the "V" structure of coil also reduces the noise.

旗舰型系列使用交互“V型”盘管，并采用带内螺纹铜管及冲缝型翅片，比传统式盘管机组有更高的传热效率。采用“V型”结构盘管可使制冷系统的循环与制冷负荷相匹配，并且使通过盘管表面的气流更加平稳，最大限度的降低机组的噪声。



The micro processing controller of flagship series is equipped with MCU with backlight under normal circumstances that can display the sequence number of moisture and humidity, the set point temperature and relative humidity, the working state display (refrigeration, heating, humidification, and dehumidification), fan status, and alarm. Touch panel controller displays the last 48 hours of temperature and relative humidity curve. The user-friendly menu allows the operator to easily query the state of the system. For example: high temperature, low temperature, high humidity, low humidity, air flow loss, replacing the filter, compressor high pressure alarm etc. Multilevel password protection function includes the set point changes, the alarm threshold settings, communication settings, and unit setting items. Built in power saving function is allowed automatic closing unit when the input power is reached the range of setting voltage. Backup battery installed in the control board recording the parameters of units prevents when the main power supply is failure. Each module of the flagship series has internal controller independently, and according to the environmental conditions, each module is connected by the alternate component. When a module has alarm, the controller automatic starts standby module. The controller can also balance the cycle time of module. Touch panel controller can be connected with PC through the RS232 interface for monitoring all data sets. By using the PC on site and the modulator can realize the remote monitoring for the unit. Open communication software is convenient for connecting to the building's control system, for example: JOHNSON, HONEYWELL, and etc.

旗舰型系列的微处理控制器配有带背景灯的触控式显示器，正常情况下，可以显示回风湿度和环境湿度、机组序列、温度和相对湿度设定点、工作状态显示(制冷、加热、加湿、去湿)、风机状态、及各种报警。触控式控制器可显示最近 48 小时内的温度和相对湿度曲线。友好的用户操作菜单界面可以使操作人员很方便的对系统和报警状态进行查询及重置，例如：高温、低温、高湿、低湿、气流丢失、更换过滤器、压缩机超高压报警等等。同时具备多级密码保护功能，包括设定点改变、报警阈值设定、通讯设置、及机组设置等项目都可以通过密码保护。内置电源节省功能可以在输入电源低于设定电压范围时自动关闭机组。当主电源故障时，安装在控制板上的备份电池可保存机组的设定参数和历史记录。旗舰型系列的每个模块都有独立的内部控制器，可根据现场情况将各模块通过备选组件连接。当某一模块出现报警时，自动启动备用模块，并且可以使模块循环工作，平衡各模块的使用时间。触控式控制器通过 RS232 接口可以连接 PC，可监控机组所有的数据。如采用了远程 PC 和调制解调器则可实现机组的远程监控。开放通讯软件方便与主要的(BAS)楼宇自动控制系统相连接，例如：JOHNSON, HONEYWELL 等。



All the routine maintenance work of flagship series can be accessed in front and all parts can be taken out easily. Air filter can also be replaced in front. Under the normal operation condition, the maintenance of the refrigeration system can be carried out.

旗舰型系列的所有日常维护工作都可以在机组正面完成，所有部件都可以从机组正面取出。旗舰型系列的空气过滤器可以从机组正面进行更换。在机组正常运行情况下，可以对制冷系统进行检修。



In order to ensure the whole system is reliable and efficient, the suitable air condenser is used according to the environment temperature of outdoor. In order to prevent the intrusion of moisture and impurities in the transport process, the unit has been in the factory pre filled with dry nitrogen. In the installation of unit should pay attention to set pipe and the liquid pipe, according to the distance of the condenser, choose suitable specification and in accordance with the requirements of copper tube.

为了保证整个系统工作可靠及高效，需根据室外环境温度匹配合适的空气冷凝器。为防止在运输过程中潮气及杂物的侵入，机组在出厂前已预先充注干燥的氮气。在安装机组时需注意机组的气管和液管，根据冷凝器的安装距离，选择规格合适且符合制冷要求的铜管。

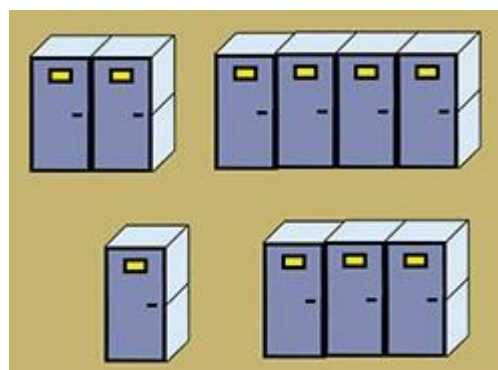
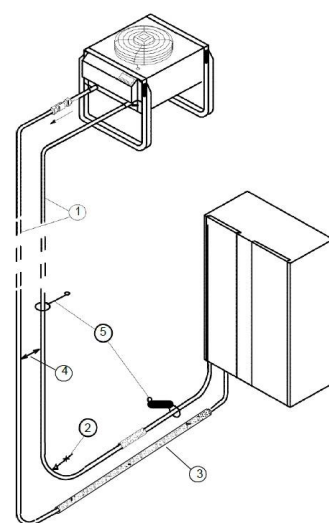

All series is designed as the modular with uniform appearance and is also supported the module combination. A variety of models can be selected by customers, and is suitable for various conditions. A wide range of optional accessories is used to adapt the variety of environmental requirements. Each unit has adjustable speed fan, using a combination of without considering the pressure problems.

模块化设计，外观更美观、一致；模块间任意组合。

多种型号可供选择，适用各种条件。

多种可选附件，适应各种环境要求。

每台机组标配可调速风扇，组合使用无需考虑均压问题。

All series using recycled industrial materials plays a positive role in environmental protection. Sandwich type panel structure, the middle of flame retardant, heat insulation, and noise reduction material, provide the fire performance of A0 class.

系列采用可循环使用的工业材料，对环境保护起着积极的作用。三明治夹层式面板结构，中间加阻燃隔热降噪材料，提供具有 A0 级防火性能。



Specifications for flagship series (flagship 系列规格):

XXU/OA		28U	34U	40U	26U	32U	42U	46U	55U	65U
Cooling sys. (制冷系统)		Single 单	Single 单	Single 单	Double 双	Double 双	Double 双	Double 双	Double 双	Double 双
Wind rate (风量)	m ³ /h	9980	11040	12510	9980	11040	12510	13500	14560	15680
Max. pre. (最大风压)	kW	430	400	370	430	400	370	320	230	165
Input power of fan (风机输入功率)	kW	2.2	2.4	2.7	2.2	2.4	2.7	3.0	3.7	4.1
Total cooling cap. (总冷量)	kW	30.5	35.4	44.3	29.0	35.5	42.5	53.7	58.7	66.6
Humidity cap. (湿冷量)	kW	29.9	34.7	42.9	29.0	34.1	41.7	51.6	54.2	60.6
Noise (噪音)	dB(A)	56.5	57.6	59.2	56.5	57.6	59.0	60.8	62.6	63.8
Input power of com. (压缩机输入功率)	kW	6.2	7.1	8.9	5.8	7.2	8.7	11.7	13.8	15.0
Hud. Heat ratio (湿热比)		0.98	0.98	0.97	1.00	0.96	0.98	0.96	0.92	0.91
Efficiency (效能比)		3.63	3.73	3.81	3.62	3.71	3.74	3.66	3.23	3.34
Max. Hum. (最大加湿量)	kg/h	9-12	9-12	9-12	9-12	9-12	9-12	9-12	9-12	9-12
Power of hum. (加湿功率)	kW	5.8	5.8	5.8	5.8	5.8	5.8	5.8	5.8	5.8
Electrode (电加热)	kg/h	11.7	11.7	11.7	11.7	11.7	11.7	11.7	17.55	17.55
Qty. of fan (风机数量)	n	2	2	2	2	2	2	2	2	2
Motor rate power (电机额定功率)	kW	2.5	2.5	2.5	2.5	2.5	2.5	2.5	2.5	2.5
Qty. of com. (压缩机数量)	n	1	1	1	2	2	2	2	2	2
Qty. of eva. (蒸发器数量)	n	1	1	1	1	1	1	1	2	2
Filter grade (过滤器级数)		G4	G4	G4	G4	G4	G4	G4	G4	G4
Size (尺寸) (LxWxH)	mm	1750x890x1800								
Weight (重量)	kg	580	585	590	580	585	590	605	630	630
Total power (最大耗电量)	kW	23.46	24.34	26.72	19.87	20.57	21.56	23.11	30.01	30.61

Advantages: (优点)

- Advanced MPC (先进微处理控制器)
- Maintenance (可维护性)
- Air cooling system (气冷却系统)
- Flexible installation (安装方式灵活多样)
- Copeland compressor (谷轮压缩机)
- Large evaporator coil (大的蒸发器盘管)
- Low noise (低噪声)
- Password protection (密码保护)
- Mixed Flagship+FC operation (旗舰型加自然冷却型有显著的节能效果)
- Hot air bypass (热气旁通)
- The floor bracket (地板支架)
- A variety of cap (多种风帽)
- Fire alarm (火灾报警)
- Frozen water accessories (冷冻水选件)
- Remote temperature and humidity sensor (远程温、湿度传感器)
- Condensate pump (冷凝水泵)
- Water leakage alarm (漏水报警)
- Emergency power off (紧急电源切断)
- Large evaporator coil (大的蒸发器盘管)
- Fan overloaded alarm (风机过载报警)
- Compressor overloaded alarm (压缩机过载报警)
- Remote control pane (远程监控面板)
- Green refrigerant (绿色制冷剂)
- Smoke detector (烟感探测器)

Family (家族成员):

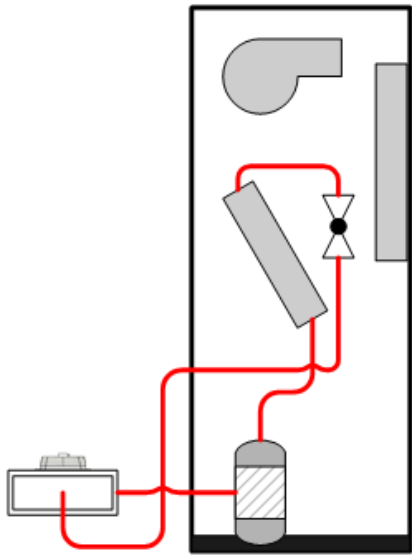

Air cooling
风冷

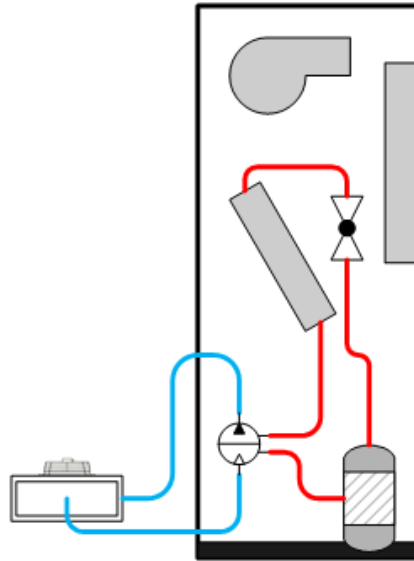

Water cooling
水冷

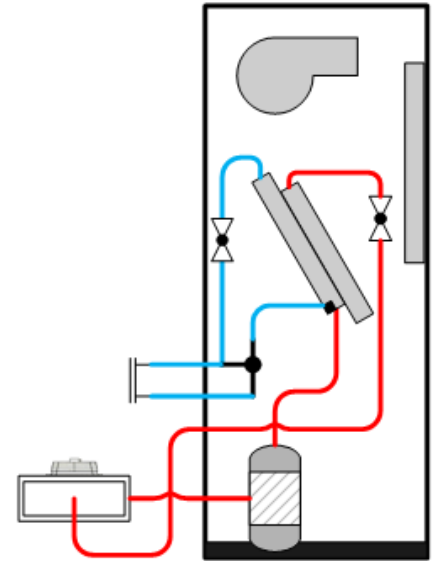

Air cooled dual-fluid
风冷双冷源

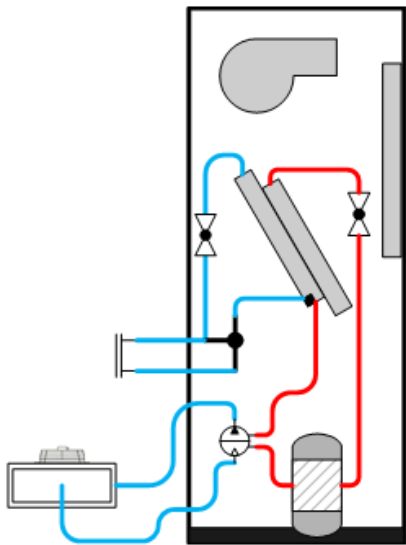

Water cooled dual-fluid
水冷双冷源

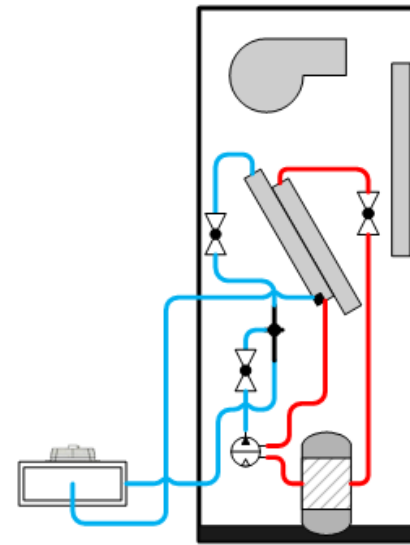

Free cooling
自由冷却

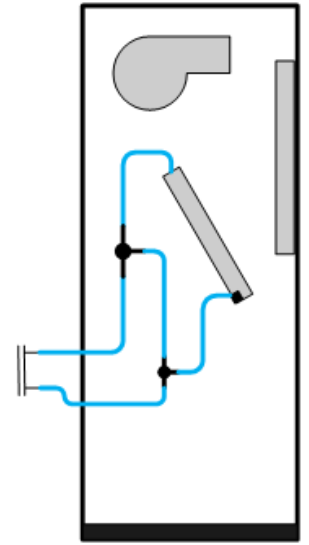

Chilled water
冷冻水

No one knows when or how disaster will strike. We just know the potential is always there, so preparation is crucial to minimizing its impact on computers, networks, users, and business. The Engineering Department provides a series of solutions for the functional architecture of unit. Customers could choose one of the functional frameworks of unit according to the actual situation. If customers cannot make the choice, our engineers will serve their needs in a professional point of view.

没有人知道何时或如何将走向灾难，我们知道可能性总是存在的，所以准备是对电脑、网络、用户和业务降低受灾难影响的重要关键。工程部门针对机组功能性架构提供了一系列的解决方案，客户可依实际的情况选择合适的功能性架构，若客户无法选择，我们的工程师会以专业的角度提供客户所需的服务。

The standard diameter and electrical data series (标准管径及电气技术数据):

Model (型号)	Tube diameter for air (气管直径) (mm)	Tube diameter for liquid (液管直径) (mm)	Running current (运行电流) FLA(A)	Current protection (断路器保护电流) I Δ n=0.3A(400V)	Min. cable diameter (最小电缆线直径) (mm)
S03/S04/S05/W03/W04/W05	12×1	12×1	16.9	32A	6
S07/W08	16×1	12×1	17.5	32A	6
S10/W10	16×1	12×1	18.5	32A	6
S12	16×1	12×1	20	32A	6
S13/W13	18×1	16×1	22	32A	6
S16/S17/S18/W16/W18	18×1	16×1	24	32A	10
S20/S21/W21	18×1	16×1	28	50A	10
S23/W23	18×1	16×1	30	50A	10
S25/M25/W26	22×1	18×1	31	50A	10
S29/M29	22×1	18×1	43.1	50A	10
M32	22×1	18×1	45.2	50A	10
M34	18×1	16×1	45.4	50A	16
M35	28×1	22×1	47.9	63A	10
M41	28×1	22×1	52.7	63A	16
M42	22×1	18×1	46.8	63A	16
M47	28×1	22×1	57.5	63A	16
M50	22×1	18×1	64.5	80A	25
M58	22×1	22×1	68.3	80A	25
M66	28×1	22×1	69.3	80A	25
28A/W/F/D/H	22×1	18×1	45.2	50A	10
34A/W/F/D/H	28×1	22×1	47.9	50A	10
40A/W/F/D/H	28×1	22×1	52.7	63A	16
26A/W/F/D/H	18×1	18×1	40.2	50A	16
32A/W/F/D/H	18×1	18×1	44.4	50A	16
42A/W/F/D/H	22×1	18×1	46.8	63A	16
46A/W/F/D/H	22×1	18×1	55.2	63A	25
55A/W	22×1	18×1	69.3	80A	25
65A/W	28×1	22×1	69.3	80A	25
81A/W	28×1	22×1	75.2	100A	35
99A/W	28×1	22×1	83.6	100A	35

P.S. The diameter of gas or liquid tube and electrical parameters will be adjusted in accordance with local regulations. The list above is for reference only.

附：气/液管径及电气参数会依照当地法规规定而调整，上述表列仅供参考。



Components (零件):

1. EV4 air filter (EV4 空气过滤器)
2. Adjustable speed fan (宇航式可调速反曲涡轮风机)
3. Electrical control (电器控制盘)
4. Micro controller (微电脑控制器)
5. Air pressure sensor (风压传感器)
6. Voltage controller for the fan (风机调压控制器)
7. Expansion valve (膨胀阀)
8. Liquid line solenoid valve (液线电磁阀)
9. Liquid pipe mirror (液管视镜)
10. Accumulator (干燥过滤器)
11. Humidifier (电极式加湿器)
12. Compressor (涡轮压缩机)
13. High voltage protection breaker (高压保护开关)
14. Low voltage protection breaker (低压保护开关)
15. Liquid storage tank (储液罐)
16. Evaporator coil (蒸发盘管)
17. 3rd grade heater (三级电加热)
18. Electric control valve (排水电磁阀)
19. Electric control valve (上水电磁阀)
20. Touch panel controller – option (图形控制器-选件)
21. Door lock (门锁)



Parameters for outdoor units (室外机参数):

Model (型号)	Length (长度) (mm)	Width (宽度) (mm)	Height (高度) (mm)	Weight (重量) (kg)
S03/S04/W03/W04	780	260	540	45
S05/S07/W05	840	285	610	50
S08/W08	830/880	310/360	710/800	52/55
S10/W10	880	360	800	55
S12/S13/W13	830/930	310/390	1260/1270	60/64
S16/S17/S18/W16/W18	930	390	1270	68
S20/S21/S23/S25/M25/P06/W21/W23/W26	1220	450	1180	80
S20/S21/S23/S25/M25/P06/W21/W23/W26 (Optional)	940	1120	935	83
S29/M29/P07/P08/P09/E08/26U/28U	1220	450	1180	95
S29/M29/P07/P08/P09/E08/26U/28U (Optional)	940	1120	1195	99
M32/M34/M35/P10/32U/34U	1500	450	1180	130
M32/M34/M35/P10/32U/34U (Optional)	940	1120	1195	133
M41/M42/Q11/P11/E14/42U	1500	450	1425	149
M41/M42/Q11/P11/E14/42U (Optional)	1190	1190	1425	154
M47/M50/Q14/P15/40U	2165	450	1180	168
M47/M50/Q14/P16/40U (Optional)	1880	1120	1030	172
M58/P17/E16/E17/46U/55U	2165	450	1180	184
M58/P17/E16/E17/46U/55U (Optional)	1880	1120	1030	189
Q17/E18	2400	450	1180	246
Q17/E18 (Optional)	1880	1120	1195	252
M66/Q19/65U	2640	450	1180	260
M66/Q19/65U (Optional)	1880	1120	1195	268
L83U	2820	1120	1030	281
Q22/Q25U	2820	1120	1195	293
L99U/Q29U	2820	1120	1195	311

P.S. (备注): The parameters for non-standard products do not shown in here, if necessary, please contact the manufacturer. The new design of components and structures for the unit will change depending on the actual situation.

非标准型号机型参数不列在此处，如果有需要，请和生产厂家联系。新机型所使用的元件及机组内部的设计会根据实际状况而有所变动。



Office: No. 125, Zhongxing Rd., Bantian,
Shenzhen City, Guangdong
Address 1: Economic Development Zone,
Futian Free Trade Zone, Shenzhen City,
Guangdong
Address 2: CBOS Industrial Park, Dongguan,
Guangdong
Phone: +86-755-89202131
Fax: +86-755-89202105
<http://www.hirossz.com>
Email: hiross@hiross.org

辦公點: 深圳坂田中興路 125 號
廠 1 深圳: 深圳福田保稅區經濟開發區
廠 2 東莞: 廣東東莞冷博工業園
電話: +86-755-89202131
傳真: +86-755-89202105
<http://www.hirossz.com>
電子郵件箱: hiross@hiross.org

Agency (经销商):

